

LISSÉ Single-lever bath mixer for wall mounting without shower set - Matte Black

LISSÉ

33 200 845









- 190-200mm projection
- circular normal flow
- automatic bath/shower diverter
- 3/8" shower outlet
- slide-on rosettes Ø 60 mm
- 1/2" connection
- gauge 150 mm - 15 mm
- max. flow 13.5 l/min at 3 bar flow pressure

Intrinsic protection against back flow.

Note: Local building codes may require the use of an anti-scald device. Please refer to remote pressure balance valve (35 910 970 90)

Intrinsic protection against back flow.

Note: Local building codes may require the use of an anti-scald device. Please refer to remote pressure balance valve (35 910 970 90)

	Matte Black	33 200 845-33
	Chrome	33 200 845-00
	Brushed Platinum	33 200 845-06
	Dark Chrome	33 200 845-19
	Brushed Chrome	33 200 845-93
	Brushed Dark Platinum	33 200 845-99

Required miscellaneous



Concealed adapter - 35 080 970-90
 •please order two adapters (USA only) 0010

33 200 845

mm [inches]

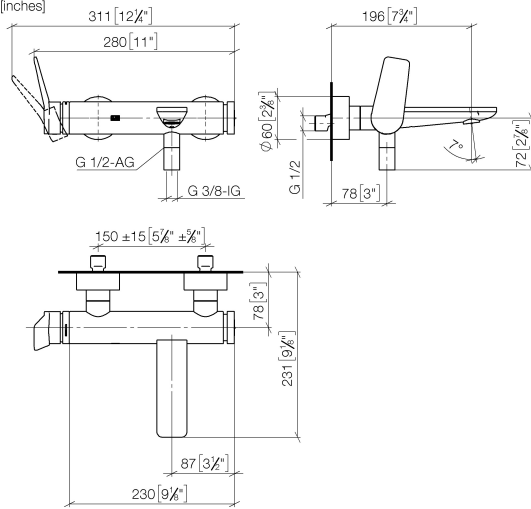

Flow rate chart

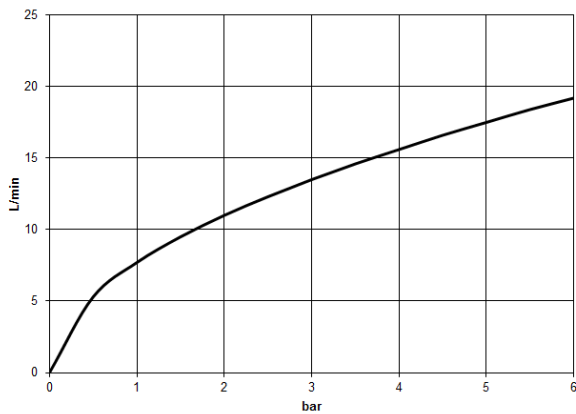

Codes & Standards

California Energy
Commission
(CEC)



LISSÉ Single-lever bath mixer for wall mounting without shower set - Matte
Black

LISSÉ

33 200 845
Certificates

LGA_9603.

WRAS_2311042.

33 200 845

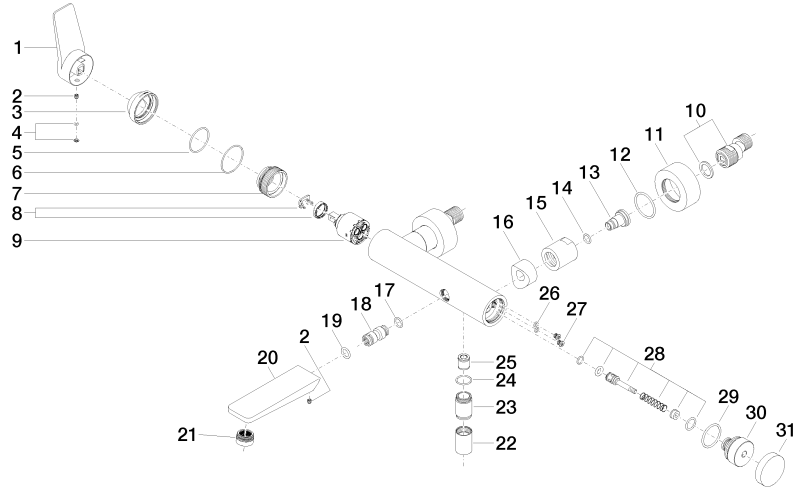

LISSÉ Single-lever bath mixer for wall mounting without shower set - Matte Black

LISSÉ

33 200 845

Spare parts list

No.	Item Number	Name	Quantity used	Delivery time
1	09 20 84 021-33	handle	1	30
2	90 31 11 030 00 90	pin	2	2
3	09 28 30 032-33	cover	1	30
4	90 31 20 087 00-33	plug	1	30
5	09 14 10 102 90	seal	1	2
6	09 14 10 190 90	seal	1	2
7	09 24 04 296 90	nut	1	2
8	90 28 10 148 00 90	accessories	1	2
9	90 15 05 064 00 90	cartridge	1	2
10	04 11 04 030 00 90	connection	2	2
11	09 27 62 004-33	rosette	2	30
12	09 14 10 119 90	seal	2	2
13	09 29 05 005 20 90	nipple	2	60
14	09 14 10 008 90	seal	2	2
15	09 23 10 048-33	nut	2	30
16	09 18 40 059-33	sleeve	2	30
17	09 14 10 003 90	seal	1	2
18	09 24 04 043 90	nipple	1	2
19	90 14 10 011 00 90	seal	1	2
20	09 11 84 012-33	spout	1	30
21	90 23 01 161 00-33	aerator	1	30
22	90 21 02 069 00-33	cover	1	30
23	09 24 03 115 20-33	nipple	1	30
24	90 14 10 032 00 90	seal	1	2
25	90 23 01 141 00 90	back-flow preventer	1	2
26	09 14 10 001 90	seal	2	2
27	09 30 30 113 20 90	screw	2	2
28	90 31 09 032 00-33	diverter	1	-
Spare part can no longer be ordered, please order the replacement item				
29	09 14 10 101 90	seal	1	2
30	09 21 10 035 20-33	nipple	1	30
31	09 20 62 031-33	handle	1	30